



GAZCO

ELECTRIC STOVES AND FIRES



# a warm welcome

It's never been easier to get the warm inviting atmosphere of a real flame fire with all the convenience, versatility and efficiency of electricity.

Using the latest flame-effect technology, Gazco has created a beautiful range of stoves and fires that provide a versatile and stunning focal point for any home – and all without the need for a chimney!

Whether you want to achieve a modern, contemporary look or a more classic, traditional interior, this brochure will help you make the right choice for your home.



Sheraton 5 Electric with Log & Pebble fuel effect on Amber flame setting. Shown with Grafton Limestone mantel







Liberty 85 Electric in White with matching White Bench, with Log & Pebble fuel effect and Amber flame setting

# contents

Complete Peace of Mind .....04  
 Creative Control ..... 05

## Traditional Electric Stoves

Chesterfield .....06 - 07  
 Sheraton .....08 - 09  
 Stockton..... 10 - 11  
 Marlborough2..... 12 - 13  
 Huntingdon..... 14 - 15

## Contemporary Electric Stoves

Vogue Midi ..... 16 - 17  
 Vogue Midi T ..... 18 - 19  
 Vision .....20 - 21  
 Yeoman CL Stoves.....22 - 23  
 Liberty 85 .....24 - 27

## Riva2 670 Electric Fires .....28

Riva2 670 Verve XS.....29  
 Riva2 670 Designio2 .....30 - 31  
 Riva2 670 Evoke.....32 - 33

## Logic2 Electric Fires.....34 - 35

Logic2 Arts .....36 - 37  
 Logic2 Chartwell .....38 - 39  
 Logic2 Wave ..... 40 - 41  
 Logic2 Progress ..... 42 - 43

## Technical Information .....44 - 49

Stove Benches .....51  
 eReflex & eStudio  
 Electric Fires..... 52 - 53  
 Onyx Avanti Electric Fires .....54 - 55

# complete peace of mind

## the gazco pedigree

When you choose Gazco, quality and technology are assured. From contemporary hang on the wall fires to traditional stoves, Gazco are committed to creating the ultimate in flame effect fires. Our research and development laboratories are amongst the most advanced in the industry, ensuring that the very latest innovations are incorporated into our products.

Gazco is part of the Stovax Group. We offer a prestigious product range, which includes everything from the traditional to the ultra-contemporary in a wide array of styles and sizes. Whether your choice is solid fuel, gas, or electric you can be sure to find a stove or fireplace from our range to add the perfect warmth and character to your home. Full details of the Stovax Group's range of products can be found at: [www.stovax.com](http://www.stovax.com)

Gazco is an ISO9001 and ISO14001 accredited company. Our rigorous quality control system ensures that all our appliances are safety checked and that they comply with the appropriate regulations, with all fires in this brochure bearing the UKCA and CE mark. Similarly, our environmental management systems ensure we work in a sustainable manner, whilst endeavouring to protect the environment by minimising any possible impact from our operations.



## warranty information

Your Gazco retailer will provide you with a Two Year Warranty for your new electric fire providing it is registered with Gazco. Please note this warranty excludes certain consumable parts. Fires purchased outside of Gazco's Expert Retailer Network will carry a standard One Year Non-Extendable Warranty. Full warranty details, terms and conditions are available at: [www.gazco.com](http://www.gazco.com)



## expert retailer network

We take great care to ensure that our fires are designed, tested and manufactured to the highest possible quality and safety standards. We are just as concerned to make certain that they are sold and installed correctly so that you will enjoy years of pleasure from your purchase.

Accordingly, you will find our products are only available from experienced, independent retailers who will be happy to show you a selection of models locally in their showrooms, often fully operational. These independent retailers will discuss your individual requirements covering both technical issues and design, to ensure that you select the most appropriate product for your home. They will also be able to advise on, or assist with, the installation process as well as help provide any after-sales support and servicing your appliance may require in the future.

Whilst we encourage our retailers to promote fireplace products and their outlets via the internet, we do not believe suitable levels of customer care and satisfaction can be obtained from purchasing the product only online and we would strongly recommend that you consider this when undertaking your research and making a purchasing decision. Furthermore, please be aware that we do not offer technical support (beyond our statutory responsibilities) to products bought via nationwide online sales, where this support would normally be offered by one of our qualified, independent retailers.

In addition, Gazco fires purchased from within our Expert Retailer Network will have the additional benefit of an extended warranty period, subject to terms and conditions. Full details can be found at: [www.gazco.com](http://www.gazco.com)

## find your local retailer

You can find your nearest expert retailer by visiting: [www.gazco.com/retailers](http://www.gazco.com/retailers)



We are proud to have been recognised as an award-winning manufacturer, for our high-quality products and innovative technology. Find out more at [gazco.com/awards](http://gazco.com/awards)





**WIN** the cost of your product back!

by registering your product online for your free extended warranty. See page 51 for details.

Logic2 Electric Chartwell with Polished effect front, Polished Steel effect frame, and Grey Pebble fuel bed on Amber flame setting.

# creative control

All Gazco electric fires and stoves come with a Programmable Thermostatic Eco Remote Control. This easy-to-use handset gives you full control over a host of features, including temperature control as well as visuals.

## flame options

Choose from Amber, Blue\*\* or a combination depending on your mood, with five brightness settings for each colour.

## chromalight fuel bed lighting

Choose from 14 different Chromalight LED fuel bed settings on electric stoves\*, with 13 vibrant colour choices or a gradually changing spectrum of each.

## thermostatic ambient heating

Set the optimum temperature for your room between 15°C and 25°C. The fire or stove will use its thermostat to manage heating power, reaching the desired temperature as efficiently as possible.

## comfort temperature

Eco and Comfort settings allow you to adjust the thermostat by a further +/- 4°C for greater temperature control.

## daily and weekly heating

Fires and stoves can be programmed to provide heat at certain times of the day or week, using the handset's Daily and Weekly Timer function.

## heating advance mode

Heating cycles can be easily delayed or advanced if desired, without disrupting daily or weekly programming.

## adaptive start control

Advanced thermostat technology allows the fire or stove to turn on up to 45 minutes in advance of a scheduled time to ensure the room is at the right temperature, when you want it to be.

## open window detection

To save energy, a sudden drop in room temperature of 4°C due to an open window or door will cause the fire or stove to stop heating the room. Heating can be easily resumed by pressing the heat button again or closing the window.

Gazco's energy saving features ensure all models comply with stringent Ecodesign energy product standards.



\*Available on electric stoves only. Also available on eReflex and eStudio fires shown on pages 52 to 53. \*\*Not applicable to Riva2 670 electric models

SHOWROOM  
EXCLUSIVE



Chesterfield 5 Electric with Log &  
Pebble fuel effect on Amber flame setting

# chesterfield 5 electric



View the Video

at [www.gazco.com/chesterfieldelectric](http://www.gazco.com/chesterfieldelectric)



Chesterfield 5 Electric with Log & Pebble fuel effect on Amber flame setting. Shown with Pembroke wooden mantel in warm white.



Chesterfield 5 Electric with Log & Pebble fuel effect on Amber flame setting

Elegantly styled, yet decidedly sophisticated, the Chesterfield 5 Electric combines designer looks with traditional aesthetics. For unparalleled authenticity, the Chesterfield 5 features the same cast iron and heavy gauge steel construction used in its woodburning and gas versions. Inside, this advanced electric stove creates a superb flame picture thanks to the Chromalight technology and interchangeable, highly realistic log effects.

**Finish**  
Matt Black

**Heat Output**  
0.75 - 1.50kW  
(or flame effect only)

**Flame Visual Settings**  
Amber, Blue, or Amber  
with Blue accent

**Interchangeable Fuel Beds**  
Log & Pebble effect  
Crystal Ice effect  
**Dimensions w x h x d (mm)**  
472 x 614 x 391



Programmable  
Thermostatic  
Eco Remote  
Control



SHOWROOM  
EXCLUSIVE



Sheraton 5 Electric with Log & Pebble fuel effect on Amber flame setting



# sheraton 5 electric



View the Video

at [www.gazco.com/sheratonelectric](http://www.gazco.com/sheratonelectric)



Sheraton 5 Electric with Log & Pebble fuel effect on Amber with Blue accent flame setting



Sheraton 5 Electric with Log & Pebble fuel effect on Amber flame setting with Grafton Limestone mantel



The Sheraton 5 Electric stove brings style, elegance, and remarkably realistic flame visuals to any interior. Cast iron bevelling and corning to the door, top plate and base give this stove a classic but timeless appearance that will suit modern and traditional settings alike.

Featuring a choice of fuel effects alongside our Chromalight® Immersive LED systems, the Sheraton 5 Electric gives you a variety of display options that can be mixed and matched to create a bespoke focal point.

**Finish**  
Matt Black

**Heat Output**  
0.75 - 1.50kW  
(or flame effect only)

**Flame Visual Settings**  
Amber, Blue, or Amber with Blue accent

**Interchangeable Fuel Beds**  
Log & Pebble effect  
Crystal Ice effect

**Dimensions w x h x d (mm)**  
458 x 614 x 371



Programmable  
Thermostatic  
Eco Remote  
Control

# stockton electric



Stockton2 Medium Electric with Log & Pebble fuel effect on Amber flame setting



Stockton2 Small Electric with Log & Pebble fuel effect on Amber flame setting

With their cast iron doors and heavy gauge steel bodies, Stockton stoves combine the classic looks of a woodburning stove with the ease and convenience of electric.

Featuring our advanced Chromalight® technology, the Stockton's flame effects are projected among the fuel bed for a three-dimensional visual, whilst the various fuel effect options are lit from above and below for increased realism. The range of LED colour settings and interchangeable fuel bed options gives you the freedom to tailor your stove's visuals to suit your mood.

#### Finish

Matt Black

#### Heat Output

1.00kW - 2.00kW  
(or flame effect only)

#### Flame Visual Settings

Amber, Blue, or Amber with Blue accent

#### Interchangeable Fuel Beds

Log & Pebble effect  
Crystal Ice effect

#### Dimensions w x h x d (mm)

Stockton2 Small: 438 x 525 x 338

Stockton 5: 481 x 544 x 337

Stockton2 Medium: 601 x 616 x 412



Programmable  
Thermostatic  
Eco Remote  
Control





Stockton 5 Electric with Log & Pebble fuel effect on Amber flame setting

# marlborough2 electric



Marlborough2 Small Electric with Log & Pebble fuel effect on Amber flame setting



Marlborough2 Medium Electric with Log & Pebble fuel effect on Amber flame setting

Country or city, traditional or contemporary, the innovative Marlborough2 Electric has the flexibility to suit your lifestyle and your décor. With their expansive viewing windows, enjoy the warming flame visuals with or without the heat from the comfort of your sofa.

## Finish

Matt Black

## Heat Output

1.00 - 2.00kW  
(or flame effect only)

## Flame Visual Settings

Amber, Blue, or Amber with Blue accent

## Interchangeable Fuel Beds

Log & Pebble effect  
Crystal Ice effect

## Dimensions w x h x d (mm)

Small: 429 x 533 x 280

Medium: 600 x 583 x 380



Programmable  
Thermostatic  
Eco Remote  
Control





# huntingdon electric



Huntingdon 30 Electric with Tracery Door in Matt Ivory with Log & Pebble fuel effect on Amber flame setting



Huntingdon 20 Electric with Tracery Door in Matt Black with Log & Pebble fuel effect on Amber flame setting

The fine castings of the Huntingdon Electric range are brought alive with Gazco's Chromalight® technology, The Huntingdon Electric range is available in a number of finishes to complement your home. For even more styling options, each size is also offered in either clear door or tracery door versions.

#### Finish

Matt Black  
Matt Ivory  
Ivory Enamel

#### Door Choice

Tracery Door  
Clear Door

#### Heat Output

1.00 - 2.00kW  
(or flame effect only)

#### Flame Visual Settings

Amber, Blue, or Amber with Blue accent

#### Interchangeable Fuel Beds

Log & Pebble effect  
Crystal Ice effect

#### Dimensions w x h x d (mm)

20: 413 x 536 x 324  
30: 560 x 592 x 351  
40: 641 x 653 x 397

Programmable Thermostatic  
Eco Remote Control







Huntingdon 40 Electric with Clear Door in Matt Black with Log & Pebble fuel effect on Amber flame setting. Shown with Claremont Limestone Mantel.

# vogue midi electric



Vogue Midi Midline Electric with Log & Pebble fuel effect on Amber with Blue accent flame setting



Vogue Midi Electric with Log & Pebble fuel effect on Amber flame setting

The Vogue Midi is offered in two models including the taller Midline version, which can be stacked with logs to enhance the wood burner aesthetic. Our Chromalight® Immersive LED technology lets you control flame and ember bed lighting effects to create the perfect ambience in virtually any part of the home, with a choice of fuel effects that can be mixed and matched.

The Vogue Midi is compatible with our range of stove benches, for more information see page 51.

## Finish

Matt Black

## Heat Output

0.75 - 1.50kW  
(or flame effect only)

## Flame Visual Settings

Amber, Blue, or Amber with Blue accent

## Interchangeable Fuel Beds

Log & Pebble effect  
Crystal Ice effect

## Dimensions w x h x d (mm)

Midi: 416 x 639 x 348  
Midi Midline: 416 x 791 x 348

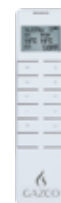

Programmable  
Thermostatic  
Eco Remote  
Control





Vogue Midi Electric with Log & Pebble fuel effect on Amber flame setting

# vogue midi t electric



View the Video  
at [www.gazco.com/electricvogue](http://www.gazco.com/electricvogue)



Vogue Midi T Electric with Log & Pebble fuel effects and Amber and Blue accent flame setting.



Vogue Midi T Midline Electric with Log & Pebble Fuel effects and Amber flame setting.



Vogue Midi T Wall Hung Electric with Log & Pebble fuel effects and Amber and Blue accent flame setting.

The stylish Vogue Midi T range comprises a collection of tall contemporary stoves. All Vogue Midi T stoves feature windows on either side of the stove body to supplement the large front window, ensuring the display is visible from almost any angle in the room.

The Vogue Midi T can be selected as a plinth-mounted stove or in Midline log store versions. Alternatively, a statement wall-hung model creates a floating installation for a strikingly modern look. The Vogue Midi T can be enhanced with our range of stove benches, for more information see page 51.

#### Finish

Matt Black

#### Heat Output

0.75 - 1.50kW  
(or flame effect only)

#### Flame Visual Settings

Amber, Blue, or Amber with Blue accent

#### Interchangeable Fuel Beds

Log & Pebble effect  
Crystal Ice effect

#### Dimensions w x h x d (mm)

Midi T: 418 x 776 x 349  
Midi T Midline: 418 x 928 x 349  
Midi T Wall Mounted : 416 x 776 x 348 (360\*)

\*360mm is depth with wall mounted bracket.



Programmable  
Thermostatic  
Eco Remote  
Control





Vogue Midi T Electric with Log & Pebble fuel effects on Amber with Blue accent flame setting

# vision electric



Vision Small Electric with Crystal-Ice fuel effect on Blue flame setting on 100 High Bench



Vision Medium Electric with Log & Pebble fuel effect on Amber flame setting

The Vision is a contemporary electric stove that comes in three sizes: Small, Midi and Medium; each sporting a highly reflective black glass door, integral glass plinth, black glass top plate and contrasting stainless steel detailing for a clean stylish look.

To increase your interior design possibilities, you can enhance your Vision by choosing from one of ten stylish Stove Benches as shown on page 51.

#### Finish

Black Glass

#### Heat Output

1.00 - 2.00kW  
(or flame effect only)

#### Flame Visual Settings

Amber, Blue, or Amber with Blue accent

#### Interchangeable Fuel Beds

Log & Pebble effect  
Crystal Ice effect

#### Dimensions w x h x d (mm)

Small: 370 x 555 x 299

Midi: 415 x 604 x 320

Medium: 535 x 676 x 363

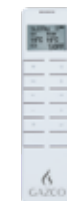

Programmable  
Thermostatic  
Eco Remote  
Control





Vision Midi Electric with Log & Pebble fuel effect on Amber flame setting





# CL electric



CL3 Electric with Log & Pebble fuel effect on Amber flame setting



CL5 Electric with Log & Pebble fuel effect on Amber flame setting



CL8 Electric with Log & Pebble fuel effect on Amber flame setting

Effortlessly bridging the gap between modern and traditional stove design, the CL Electric range balances simplicity with subtle details. CL electric stoves feature our remote controlled Chromalight LED lighting systems for extraordinarily realistic flame and ember visuals, with an assortment of fuel effects to choose from. Choose from three stove sizes to complement your home, each featuring a high quality cast iron and steel construction. CL stoves can be further enhanced with our stove benches shown on page 51.

Additional image shown on page 47.

**Finish**  
Matt Black

**Heat Output**  
1.00 – 2.00kW  
(or flame effect only)

**Flame Visual Settings**  
Amber, Blue, or Amber with Blue accent

**Interchangeable Fuel Beds**  
Log & Pebble effect  
Crystal Ice Effect

**Dimensions w x h x d (mm)**  
CL3: 371 x 541 x 313  
CL5: 416 x 552 x 333  
CL8: 553 x 604 x 374



Programmable  
Thermostatic  
Eco Remote  
Control

# liberty 85 electric



View the Video  
at [www.gazco.com/liberty85](http://www.gazco.com/liberty85)



Liberty 85 Electric in Black with matching curved Black Bench, with Log & Pebble fuel effect and Amber flame setting



Liberty 85 Electric in White with matching curved White Bench, with Crystal-ice fuel effect and Blue flame setting

Designed to make a statement, the Liberty 85 Electric stove combines bold design language, advanced technologies, and a range of customisable options. Chromalight technology projects vivid flame visuals among the glowing fuel bed for a deep, three-dimensional display. Two sophisticated finishes along with a selection of mounting options give you the freedom to choose the Liberty 85's look. Choose from either black or white front finishes, along with matching Plinth and Bench mounts to elevate this designer electric stove. The Liberty 85 can also be combined with a number of our Stove Benches shown overleaf and on page 51. Additional images shown on pages 3 and 51.

#### Finish

Black or White

#### Heat Output

1.00 – 2.00kW  
(or flame effect only)

#### Flame Visual Settings

Amber, Blue, or Amber with Blue accent

#### Interchangeable Fuel Beds

Log & Pebble effect  
Crystal Ice effect

#### Dimensions w x h x d (mm)

Liberty 85: 1110 x 596 x 300

Liberty 85 with matching Plinth: 1305 x 649 x 585

Liberty 85 with matching curved Bench: 1350 x 896 x 396



Programmable  
Thermostatic  
Eco Remote  
Control



Liberty 85 Electric in White with matching White Plinth, with Log & Pebble fuel effect and Amber with Blue accent flame setting







Liberty 85 Electric in Black with Log & Pebble fuel effect and Amber flame setting, on a 120 High Bench



# liberty 85 electric (continued)



**View the Video**  
at [www.gazco.com/liberty85](http://www.gazco.com/liberty85)



Liberty 85 Electric in White with Log & Pebble fuel effect and Amber flame setting

Liberty 85 Electric stoves come with a choice of fuel effects giving you the freedom to customise your stove's display whenever you feel like a change. Choose from highly realistic logs, Crystal Ice or a combination to suit your mood.

In addition to the matching Plinth and Bench options shown on the preceding pages, Liberty 85 stoves can also be combined with a number of our Stove Benches shown on page 51.

Additional images shown on pages 3 and 51.

#### **Finish**

Black or White

#### **Heat Output**

1.00 – 2.00kW  
(or flame effect only)

#### **Flame Visual Settings**

Amber, Blue, or Amber with Blue accent

#### **Interchangeable Fuel Beds**

Log & Pebble effect  
Crystal Ice effect

#### **Dimensions w x h x d (mm)**

Liberty 85: 1110 x 596 x 300

For stove bench dimensions, see page 51.



Programmable  
Thermostatic  
Eco Remote  
Control

# riva2 670 electric fires

Riva2 670 fires bring a relaxing focal point to any home, with all the convenience of instant electric heat.

Designed to fit a wide variety of installation requirements, Riva2 670 electric fires can either be recessed into the wall, hearth-mounted into a traditional fireplace opening or alternatively hung directly on the wall with a wall-mounting box for easy installation.



## frame options

### Designio2



*Graphite, Iridium & Black Glass*

### Verve XS



*Graphite*

### Evoke



*Graphite & Black Glass*



Riva2 670 Electric Designio2 in Graphite



# riva2 670 verve xs



Riva2 670 Electric Verve XS in Graphite

The stylish Verve XS transforms the Riva2 670 with a 3D frame designed to create maximum visual impact in your home. This subtly curving frame choice comes in smart Graphite to suit a variety of settings.

The Riva2 670's highly realistic fuel bed is enhanced by Gazco's stunning flame-effect, offering the ambiance of a real log flame with the instant convenience of electric.

**Finish**  
Graphite

**Fuel Bed**  
Log effect

**Heat Output**  
1.00 - 2.00kW  
(or flame effect only)

**Frame Dimensions  
w x h x d (mm)**  
1000 x 622 x 41\*



Programmable  
Thermostatic  
Eco Remote  
Control

\* Depth when recessed into wall. For more information on the optional wall-mounting box as well as firebox dimensions, please see page 48.

For information on the remote control features see page 5.





# riva2 670 designio2

Riva2 670 Electric Designio2 Steel in Iridium



Riva2 670 Electric Designio2 Steel in Graphite



The Designio2 Glass and Steel frames offer a selection of contemporary framing options for the Riva2 670 electric fire.

The Designio2 Glass adds a striking black glass surround, with glossy reflective surfaces that enhance the fire's luxury aesthetic. For understated style, the Designio2 Steel frames the fire with a sophisticated metal surround, available in either Graphite or Iridium finishes to complement your décor.

Designio2 frames can be either wall or hearth mounted depending on your tastes.

Additional images shown on pages 28 and 48.

**Finish**  
Black Glass  
Graphite  
Iridium

**Fuel Bed**  
Log effect

**Heat Output**  
1.00 - 2.00kW  
(or flame effect only)

**Frame Dimensions  
w x h x d (mm)**  
735 x 569 x 40\*



Programmable  
Thermostatic  
Eco Remote  
Control

\* Depth when recessed into wall. For more information on the optional wall-mounting box as well as firebox dimensions, please see page 48.

For information on the remote control features see page 5.

# riva2 670 evoke



Riva2 670 Electric Evoke Glass  
with Black Glass front & Graphite rear



Riva2 670 Electric Evoke Steel  
with Graphite front & rear

Minimalist in design but bold in statement, the Evoke frame adds further presence to the Riva2 670. Choose from Steel or Glass fronts to suit your living area.

All Riva2 670 Electric fires can be recessed into a pre-constructed hole for a more minimalist installation but can also be hung directly on the wall with the optional wall-mounting box.

See rear cover for additional image.

**Front Finish**  
Black Glass  
Graphite

**Fuel Bed**  
Log effect

**Heat Output**  
1.00 - 2.00kW  
(or flame effect only)

**Frame Dimensions  
w x h x d (mm)**  
920 x 622 x 41\*



Programmable  
Thermostatic  
Eco Remote  
Control

\* Depth when recessed into wall. For more information on the optional wall-mounting box as well as firebox dimensions, please see page 48.

For information on the remote control features see page 5.





Riva2 670 Electric Evoke Glass  
with Black Glass front & Graphite rear



Logic2 Electric Chartwell with Brushed Steel Effect Frame, Highlight Polished Front and Grey Pebble fuel bed on Amber flame setting. Shown with Claremont Limestone mantel, Stovax Burlington Cast front and Polished Insert Panel.



# logic2 electric fires

Featuring advanced LED technology, the Logic2 Electric Inset fire range offers captivating, life-like flame visuals for instant fireside ambience. Designed to fit easily into a standard fireplace opening, 3" rebated mantel with slip or simply against a flat wall using the optional spacer frame, this versatile fire can be enjoyed in almost any interior setting.

The Logic2 features various LED flame effects including deep amber, cool blue or a combination of the two. Using the handset that gives you full control over the fire's features, the Logic2's flames can be set to five brightness settings and can also be displayed with or without the heat if desired.

The Logic2's Programmable Thermostatic Eco handset also offers a number of convenient options, including Daily and Weekly scheduling.

This advanced handset also includes various energy saving features which make it Ecodesign compliant. For more information see page 5.



These stylish electric fires come complete with three easily interchangeable fuel beds which each add a unique aesthetic. The log arrangement creates a traditional woodburning look, or, switch to either white and clear stones or grey pebbles for a strikingly contemporary aesthetic.

The versatile Logic2 has a choice of modern and traditionally styled frames and fronts (shown on the following pages) that allow you to customise your fire to suit your home.

## three interchangeable fuel effects



Log-effect



White & Clear Stones



Grey Pebbles



Logic2 Electric Wave with Polished Steel Effect Frame, Polished Front and Log-effect fuel bed on Amber flame setting. Shown with White Brompton wooden mantel from Stovax.

Logic2 Electric Arts with Highlight Polished front, Brushed Steel effect frame and White & Clear Stones fuel bed on mixed flame effect setting. Also shown: Art Deco wooden mantel in white, available from Stovax.





# logic2 arts



Logic2 Electric Arts with Matt Black front, Brushed Steel effect frame, & White & Clear Stone fuel bed on Blue flame setting. Shown with optional Spacer Frame.



Logic2 Electric Arts with Polished Brass effect fret & frame with Log-effect fuel bed on Amber flame setting.



Logic2 Electric Arts with Polished effect fret, Polished Steel effect frame and Log-effect fuel bed on Amber flame setting.

Taking its design origins from the Arts and Crafts movement in the early twentieth century, the Logic2 Arts embraces simplicity and clean styling. Available in a range of front and frame finishes, the Arts can be selected in a variety of combinations to suit your tastes. Using the optional spacer frame the Arts can also be installed without having to be inset into a wall, minimising building work.

\* Dimensions given are those overall visible upon installation. For detailed technical information see page 49.

## Finish Combinations

Frame Choice	Front Choice
Matt Black	Matt Black
	Brass effect
	Polished effect
	Highlight Polished
Brass effect	Brass effect
Polished Steel effect	Matt Black
	Polished effect
	Highlight Polished
Brushed Steel effect	Matt Black
	Polished effect
	Highlight Polished

## Heat Output

1.00 - 2.00kW  
(or flame effect only)

## Flame Visual Settings

Amber, Blue or mixed

## Interchangeable Fuel Beds

Log-effect  
White & Clear Stones  
Grey Pebbles

## Dimensions w x h (mm)\*

510 x 609



Programmable  
Thermostatic  
Eco Remote  
Control

# logic2 chartwell



Logic2 Electric Chartwell with Matt Black front and frame, with White & Clear Stone fuel bed on mixed flame effect setting.



Logic2 Electric Chartwell with Polished effect front, Polished Steel effect frame, and Log-effect fuel bed on Blue flame setting.



Logic2 Electric Chartwell with Polished-effect Brass front and frame, with Log-effect fuel bed on Amber flame setting.

The elegant Logic2 Chartwell instantly evokes the heritage and classical styling of a traditional fireplace. Available in various front and frame finishes, the Chartwell can be combined with Gazco's many mantels, fronts and insert panels to create the perfect fireplace for your home.

For easy installation, each frame choice can be used with the optional spacer frame which allows the Logic2 to be fitted directly against a flat wall. Additional image shown on page 34.

\* Dimensions given are those overall visible upon installation. For detailed technical information see page 49.

## Finish Combinations

Frame Choice	Front Choice
Matt Black	Matt Black
	Brass effect
	Polished effect
	Highlight Polished
Brass effect	Brass effect
Polished Steel effect	Matt Black
	Polished effect
	Highlight Polished
Brushed Steel effect	Matt Black
	Polished effect
	Highlight Polished

## Heat Output

1.00 - 2.00kW  
(or flame effect only)

## Flame Visual Settings

Amber, Blue or mixed

## Interchangeable Fuel Beds

Log-effect  
White & Clear Stones  
Grey Pebbles

## Dimensions w x h (mm)\*

510 x 609



Programmable  
Thermostatic  
Eco Remote  
Control





Logic2 Electric Chartwell with Highlight Polished front, Matt Black frame, and Grey Pebble fuel bed on Amber flame setting. Shown with Stovax Malmo wooden mantel\*\*.

*\*\*Mantel available to UK mainland only.*



Logic2 Electric Wave with Polished Steel Effect frame, Matt Black front with Log-effect fuel bed on Amber flame setting. Shown with Malmo wooden mantel\*\* in White from Stovax.

\*\*Mantel available to UK mainland only.



# logic2 wave



Logic2 Electric Wave with Matt Black frame and front with White & Clear Stone fuel bed on Blue flame setting.



Logic2 Electric Wave with Polished Steel Effect frame, Polished effect front with Grey Pebble fuel bed on Amber flame setting.

Blending modern and traditional styling, the Logic2 Wave features smooth lines and refined curves, suiting both contemporary and period interiors alike. The Wave can be selected in Black, Polished Steel, Brushed Steel and Brass with the option to combine different frame and front finishes for unique styling. Logic2 Wave fires are available with an optional spacer frame which allows the fire to be quickly and easily fitted onto a flat wall, if desired. Additional image shown on page 35.

\* Dimensions given are those overall visible upon installation. For detailed technical information see page 49.

## Finish Combinations

Frame Choice	Front Choice
Matt Black	Matt Black
	Brass effect
	Polished effect
	Highlight Polished
Brass effect	Brass effect
Polished Steel effect	Matt Black
	Polished effect
	Highlight Polished
Brushed Steel effect	Matt Black
	Polished effect
	Highlight Polished

## Heat Output

1.00 - 2.00kW  
(or flame effect only)

## Flame Visual Settings

Amber, Blue or mixed

## Interchangeable Fuel Beds

Log-effect  
White & Clear Stones  
Grey Pebbles

## Dimensions w x h (mm)\*

510 x 609



Programmable  
Thermostatic  
Eco Remote  
Control

# logic2 progress



Logic2 Electric Progress with Log-effect fuel bed on Amber flame setting



Logic2 Electric Progress with White & Clear Stone fuel bed on Blue flame setting

The ultra-contemporary Progress front's minimalist styling perfectly complements the advanced Logic2 fire. Featuring a smoothly curving front with a striking Iridium finish, this modern fire effortlessly makes for a designer centrepiece in any interior.

The versatile Logic2 fire range is designed to be fitted into a standard fireplace opening or flat against the wall with either a 3" rebated mantel with slip or by using the optional spacer frame.

\* Dimensions given are those overall visible upon installation. For detailed technical information see page 49.

## Finish

Iridium

## Heat Output

1.00 - 2.00kW  
(or flame effect only)

## Flame Visual Settings

Amber, Blue or mixed

## Interchangeable Fuel Beds

Log-effect  
White & Clear Stones  
Grey Pebbles

## Dimensions w x h (mm)\*

520 x 602



Programmable  
Thermostatic  
Eco Remote  
Control





# technical information - electric stoves

## chesterfield 5

Code	Model	Fuel Effect	Heat Output
605-850	Chesterfield 5	Various	0.75 - 1.50kW

Weight: 56kg

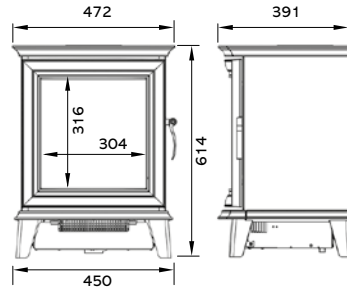

## marlborough2 range

Code	Model	Fuel Effect	Heat Output
659-085	Small	Various	1.00 - 2.00kW
659-112	Medium	Various	1.00 - 2.00kW

Dimensions (mm)

	A	B	C	D	E	F	Weight
Small	429	558	355	280	232	211	33kg
Medium	600	583	406	330	398	241	50kg

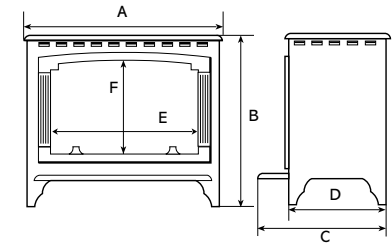

## sheraton 5

Code	Model	Fuel Effect	Heat Output
605-832	Sheraton 5	Various	0.75 - 1.50kW

Weight: 55kg

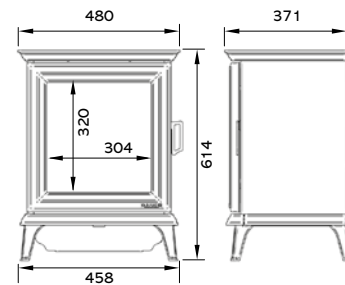

## stockton2 and stockton 5

Code	Model	Fuel Effect	Heat Output
604-144	Small	Various	1.00 - 2.00kW
604-172	5	Various	1.00 - 2.00kW
604-203	Medium	Various	1.00 - 2.00kW

Dimensions (mm)	A	B	C	D	E	F	Weight
Small	438	525	289	49	232	220	50kg
5	481	544	273	64	267	212	55kg
Medium	601	617	347	65	398	258	72kg

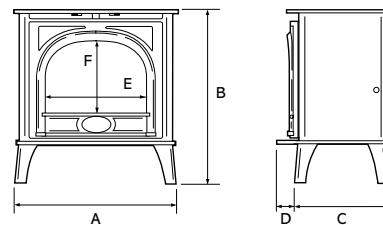

Stockton 5 Electric with Log and Pebble fuel effect on Amber with Blue accent flame setting



## huntingdon range

### Dimensions (mm)

	A	B	C	D	E	F	Weight
20	413	536	324	62	234	223	35kg
30	560	592	351	96	323	230	52kg
40	641	653	397	99	402	265	59.5kg

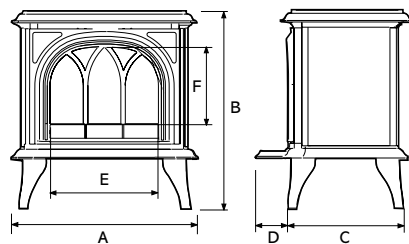

Code	Model	Colour	Fuel Effect	Door Type	Heat Output
615-258	20	Matt Black	Various	Tracery	1.00 - 2.00kW
615-624	20	Matt Ivory	Various	Tracery	1.00 - 2.00kW
615-371	20	Ivory Enamel	Various	Tracery	1.00 - 2.00kW
615-011	20	Matt Black	Various	Clear	1.00 - 2.00kW
615-050	20	Matt Ivory	Various	Clear	1.00 - 2.00kW
615-037	20	Ivory Enamel	Various	Clear	1.00 - 2.00kW
615-285	30	Matt Black	Various	Tracery	1.00 - 2.00kW
615-643	30	Matt Ivory	Various	Tracery	1.00 - 2.00kW
615-427	30	Ivory Enamel	Various	Tracery	1.00 - 2.00kW
615-094	30	Matt Black	Various	Clear	1.00 - 2.00kW
615-183	30	Matt Ivory	Various	Clear	1.00 - 2.00kW
615-142	30	Ivory Enamel	Various	Clear	1.00 - 2.00kW
615-302	40	Matt Black	Various	Tracery	1.00 - 2.00kW
615-662	40	Matt Ivory	Various	Tracery	1.00 - 2.00kW
615-613	40	Ivory Enamel	Various	Tracery	1.00 - 2.00kW
615-123	40	Matt Black	Various	Clear	1.00 - 2.00kW
615-222	40	Matt Ivory	Various	Clear	1.00 - 2.00kW
615-157	40	Ivory Enamel	Various	Clear	1.00 - 2.00kW

The above information is to assist in your choice of a suitable Gazco stove. It is not intended to be all information required to install your fire. This can be obtained from your local Gazco retailer or you can download the full installation instructions from the Gazco website at [www.gazco.com](http://www.gazco.com)

## product improvement & photography

Gazco pursue a policy of continuous product improvement, therefore, whilst our products are correct at the time of the photography, we reserve the right to make alterations and amendments. Exact product details should be discussed with your retailer at the time of purchase.

Owing to variations in studio lighting and printing inks, the colours of stoves illustrated in this brochure may differ slightly from actual models.



# technical information - electric stoves

## vogue midi

Code	Model	Fuel Effect	Heat Output
663-806	Midi	Various	0.75 - 1.50kW
663-834	Midi Midline	Various	0.75 - 1.50kW

Dimensions (mm)	A	B	C	D	E	Weight
Midi	416	639	348	306	337	42kg
Midi Midline	416	791	348	306	337	48kg

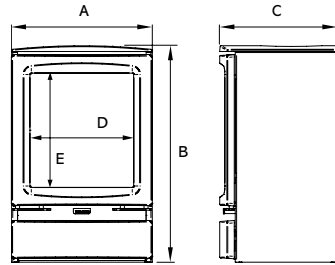

## CL range

Code	Model	Fuel Effect	Heat Output
YM681-196	CL3	Various	1.00 - 2.00kW
YM681-331	CL5	Various	1.00 - 2.00kW
YM681-374	CL8	Various	1.00 - 2.00kW

Dimensions (mm)	A	B	C	D	E	Weight
CL3	371	313	541	244	252	40kg
CL5	416	333	552	244	311	44kg
CL8	553	374	604	274	427	47kg

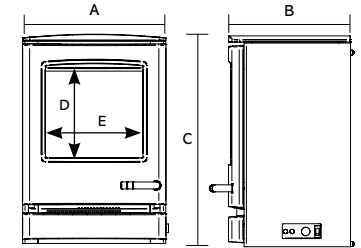

## vogue midi t

Code	Model	Fuel Effect	Heat Output
663-819	Midi T	Various	0.75 - 1.50kW
663-851	Midi T Midline	Various	0.75 - 1.50kW
663-860	Midi T Wall Mounted	Various	0.75 - 1.50kW

Dimensions (mm)	A	B	C	D	E	F	G	Weight
Midi T	417	776	348	306	475	115	434	38kg
Midi T Midline	417	927	348	306	475	115	434	44kg
Midi T Wall Mounted	417	776	348*	306	475	115	434	44kg

\*360mm is depth with wall mounting bracket.

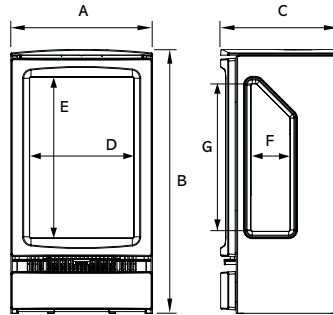

## liberty 85

Code	Model	Colour	Fuel Effect	Heat Output
610-107	Liberty 85 - Black	Black (front)	Various	2.00kW
610-126	Liberty 85 - White	White (front)	Various	2.00kW

### Plinth & Bench Mounting Choice

- 999-048 Liberty 85 Plinth - Black
- 999-087 Liberty 85 Plinth - White
- 999-127 Liberty 85 Matching Curved Bench - Black
- 999-166 Liberty 85 Matching Curved Bench - White

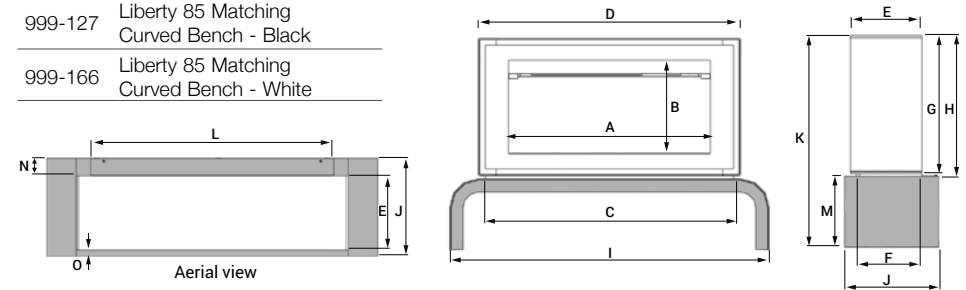

## vision range

Code	Model	Fuel Effect	Heat Output
634-808	Small	Various	1.00 - 2.00kW
634-846	Midi	Various	1.00 - 2.00kW
634-889	Medium	Various	1.00 - 2.00kW

Dimensions (mm)	A	B	C	D	E	Weight
Small	370	555	299	254	240	24kg
Midi	415	604	320	316	214	28kg
Medium	535	676	363	408	274	38kg

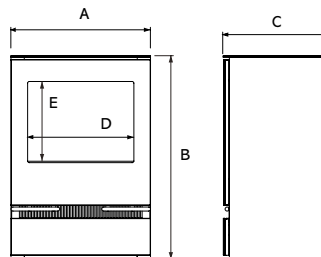

	A	B	C	D	E	F	G	H	I	J	K	L	M	N	O	Weight
Liberty 85 on Matching Curved Bench	855	396	1050	1110	300	275	584	596	1350	396	896	991	300	71	27	132kg
Liberty 85 on Plinth	855	396	1050	1110	300	275	584	596	1305	585	649	991	53	71	114	118kg
Liberty 85 (without Plinth or Bench)	855	396	1050	1110	300	275	584	596	-	-	-	-	-	-	-	107kg





CL5 Electric with Log & Pebble fuel effect on Amber flame setting

# technical information - electric fires

## riva2 670 electric

Product Code	Fuel Effect	Heat Output	Opening Size (mm)		
			w	h	d
234-872	Logs	1.00 - 2.00kW	665	535	105

### Riva2 670 Electric Wall Mounting Box

8688SL	Wall mounting box for Riva2 670 Electric Cassette (234-872)
--------	---

The wall mounting box allows you to hang your Riva2 670 directly onto the wall, without the need for an opening or recess.

### fire dimensions

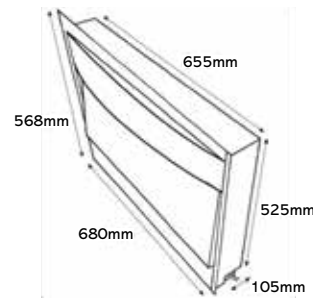

### frame information

Product Code	Description	Frame Finish	Frame Size (mm)		
			w	h	d
934-339	Designio2 frame	Black Glass	735	569	40
934-238	Designio2 frame	Graphite	735	569	40
934-238IR	Designio2 frame	Iridium	735	569	40
934-529	Evoke frame	Black Glass front with Graphite rear	920	622	41
934-601	Evoke frame	Graphite front with Graphite rear	920	622	41
934-143	Verve XS frame	Graphite	1000	621	56



Riva2 670 Electric Designio2 Steel in Graphite

# logic2 electric

## progress frame dimensions

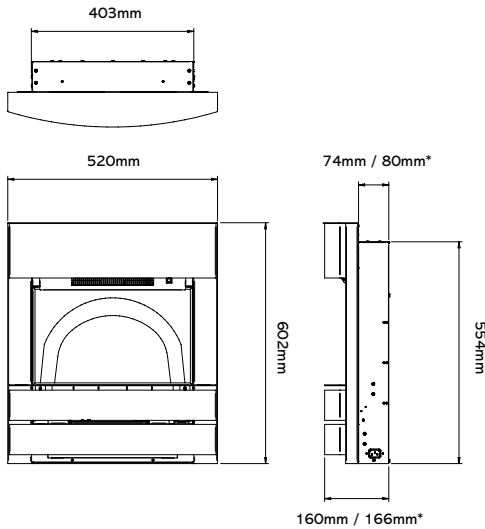

\* The depth of the Logic2 Electric fires are increased by 6mm when using an optional spacer frame.

## arts, wave & chartwell frame dimensions

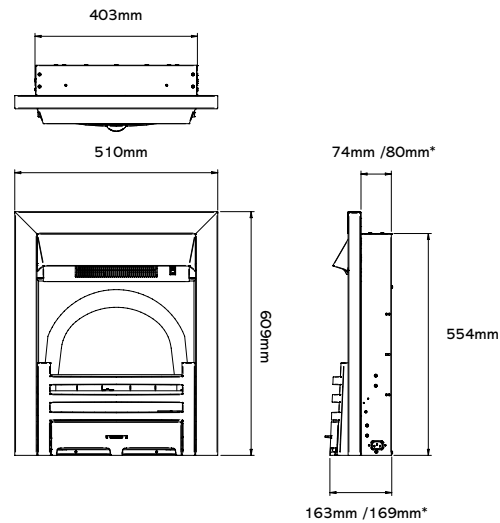

Product Code	Front	Frame Finish	Front Finish	Heat Output
--------------	-------	--------------	--------------	-------------

## arts fire information

201-005	Arts	Matt Black	Matt Black	1.00 - 2.00kW
201-038	Arts	Matt Black	Brass Effect	1.00 - 2.00kW
201-081	Arts	Matt Black	Polished Effect	1.00 - 2.00kW
201-099	Arts	Matt Black	Highlight Polished	1.00 - 2.00kW
201-132	Arts	Brass Effect	Brass Effect	1.00 - 2.00kW
201-148	Arts	Polished Steel Effect	Matt Black	1.00 - 2.00kW
201-173	Arts	Polished Steel Effect	Polished Effect	1.00 - 2.00kW
201-197	Arts	Polished Steel Effect	Highlight Polished	1.00 - 2.00kW
201-222	Arts	Brushed Steel Effect	Matt Black	1.00 - 2.00kW
201-236	Arts	Brushed Steel Effect	Polished Effect	1.00 - 2.00kW
201-401	Arts	Brushed Steel Effect	Highlight Polished	1.00 - 2.00kW

Product Code	Front	Frame Finish	Front Finish	Heat Output
--------------	-------	--------------	--------------	-------------

## wave fire information

201-416	Wave	Matt Black	Matt Black	1.00 - 2.00kW
201-504	Wave	Matt Black	Brass Effect	1.00 - 2.00kW
201-360	Wave	Matt Black	Polished Effect	1.00 - 2.00kW
201-384	Wave	Matt Black	Highlight Polished	1.00 - 2.00kW
201-688	Wave	Brass Effect	Brass Effect	1.00 - 2.00kW
201-717	Wave	Polished Steel Effect	Matt Black	1.00 - 2.00kW
201-591	Wave	Polished Steel Effect	Polished Effect	1.00 - 2.00kW
201-828	Wave	Polished Steel Effect	Highlight Polished	1.00 - 2.00kW
201-757	Wave	Brushed Steel Effect	Matt Black	1.00 - 2.00kW
201-269	Wave	Brushed Steel Effect	Polished Effect	1.00 - 2.00kW
201-323	Wave	Brushed Steel Effect	Highlight Polished	1.00 - 2.00kW

## chartwell fire information

201-742	Chartwell	Matt Black	Matt Black	1.00 - 2.00kW
201-708	Chartwell	Matt Black	Brass Effect	1.00 - 2.00kW
201-655	Chartwell	Matt Black	Polished Effect	1.00 - 2.00kW
201-626	Chartwell	Matt Black	Highlight Polished	1.00 - 2.00kW
201-554	Chartwell	Brass Effect	Brass Effect	1.00 - 2.00kW
201-511	Chartwell	Polished Steel Effect	Matt Black	1.00 - 2.00kW
201-392	Chartwell	Polished Steel Effect	Polished Effect	1.00 - 2.00kW
201-314	Chartwell	Polished Steel Effect	Highlight Polished	1.00 - 2.00kW
201-293	Chartwell	Brushed Steel Effect	Matt Black	1.00 - 2.00kW
201-024	Chartwell	Brushed Steel Effect	Polished Effect	1.00 - 2.00kW
201-070	Chartwell	Brushed Steel Effect	Highlight Polished	1.00 - 2.00kW

## progress fire information

201-103	Progress	Iridium		1.00 - 2.00kW
---------	----------	---------	--	---------------

## optional spacer frames†

901-815	Logic2 Electric Arts, Chartwell & Wave Spacer Frame - Black
901-860	Logic2 Electric Progress Spacer Frame - Graphite

† Logic2 Electric Spacer Frames are for use when installing onto a flat wall.





Chesterfield 5 Electric with Log & Pebble fuel effect on Amber flame setting

# further information

## stove benches

These versatile steel benches are compatible with the Vision, Vogue, CL, and Liberty 85 stoves. With a variety of sizes they offer greater design possibilities such as central or offset stove positioning, expanding your styling options.



Product Code	Bench	W (mm)	H (mm)	D (mm)
RVACLB45BHT	45 Low bench*	450	250	420
RVACB45BHT	45 High bench*	450	350	420
RVACLB100BHT	100 Low bench*	1000	250	420
RVACB100BHT	100 High bench*	1000	350	420
RVACLB120BHT	120 Low bench	1200	250	420
RVACB120BHT	120 High bench	1200	350	420
RVACLB140BHT	140 Low bench	1400	250	420
RVACB140BHT	140 High bench	1400	350	420
RVACLB180BHT	180 Low bench	1800	250	465
RVACB180BHT	180 High bench	1800	350	465

### Deeper Bench Options (500mm Deep)

RVACLB120BHT	120 Low bench	1200	250	500
RVACB120BHT	120 High bench	1200	350	500
RVACLB140BHT	140 Low bench	1400	250	500
RVACB140BHT	140 High bench	1400	350	500
RVACLB180BHT	180 Low bench	1800	250	500
RVACB180BHT	180 High bench	1800	350	500

\*Not compatible with Liberty 85 Electric Stoves

# WIN

## the cost of your product back!\*

For further home inspiration you can **view real life installations** at our Customer Showcase page and share your thoughts and photos of your new stove or fire installation to enter our draw!

- We will publish your entry on our Customer Showcase
- You will be entered into a draw for the chance to win the cost of your product back
- **Gain a second entry** by registering your product online for your free extended warranty at [gazco.com/registration](http://gazco.com/registration)



View real life installations and submit your review at [gazco.com/customershowcase](http://gazco.com/customershowcase)

\* Terms and conditions apply. See online for details



# more Gazco electric fires



eReflex 150RW installed as a three-sided fire with optional mood lighting kit.



eReflex 75R Inset with Log & Pebble fuel effect on Amber flame setting. Shown with Claremont Mantel in Limestone with matching slip set.

The Gazco electric fire collection also includes the eReflex and eStudio ranges.

Offering captivating flame and ember effects in a choice of colours, both the eReflex and eStudio feature our immersive Chromalight LED Systems. Combining their innovative lighting technology with the various highly realistic fuel effect choices, each fire brings stunning, atmospheric visuals to your living area.

Together, these designer electric fire ranges present an array of sizes and installation choices, with Inset, Multi-Sided and wall mounted options to suit your home.

For more information on eReflex and eStudio electric fires please contact your local retailer or visit:

[www.gazco.com](http://www.gazco.com), where you can download either range's brochure.







eStudio 135R with optional Silver Birch log-effect on Amber with Yellow accent flame setting. Shown with optional Mood Lighting Kit.

# onyx

## Avanti Electric Fires



Remote and App Control



chromalight<sup>®</sup>  
plus



Avanti 150RW with Split Oak Log-effect, installed as a single-sided fire. Shown with optional Mood Lighting System.

In addition to the eStudio & eReflex ranges, the Stovax Heating Group also includes the extraordinary Avanti electric range from our Onyx brand.

Delivering the ultimate in electric fire innovation, the Avanti's Chromalight<sup>®</sup> Plus systems employ layer upon layer of visual technology to weave a palette of captivating flame and lighting effects, with each effect highly customisable. Crisp flame visuals appear to dance and soar between true-to-life log effects, dynamically lit from all angles for absolute immersion.

For more information on the full Avanti electric range, please contact your local retailer or view and download the full brochure at: [www.onyxfires.com](http://www.onyxfires.com).







View  
the   
Video

or visit our website:  
[onyxfires.com/avanti](https://onyxfires.com/avanti)





Logic2 Electric Chartwell with Brushed Steel Effect Frame, Highlight Polished Front and Grey Pebble fuel bed on Amber flame setting. Shown with Claremont Limestone mantel, Stovax Burlington Cast front and Polished Insert Panel.



Riva2 670 Electric Evoke Glass with Black Glass front & Graphite rear



Gazco Limited, Osprey Road, Sowton Industrial Estate, Exeter, Devon, England EX2 7JG • **Tel:** 01392 261900  
**Trade Sales:** 01392 261999 **NI:** 01392 261990 • **Email:** info@gazco.com **NI:** northernireland@gazco.com  
**Export Sales:** +44 1392 261990 • **Export Email:** exportsales@gazco.com

gazco.com   

Gazco gratefully acknowledges the assistance of the following companies with photographic settings:

www.amara.com; www.furniturevillage.co.uk; www.theorangerie.co.uk; www.habitat.co.uk; www.houseoffraser.co.uk; www.electique.co.uk; www.debenhams.com;  
 www.next.co.uk; www.mokodirect.co.uk; www.marksandspencer.com; www.frenchconnection.com; www.urbanoutfitters.com/uk; www.tkmaxx.com; www.homesense.com;  
 www.johnlewis.com; www.coxandcox.co.uk; www.urbanara.co.uk; www.amoslighting.co.uk; www.farmington.co.uk; www.bnsp.co.uk; www.grandisson.com;  
 www.rudloe-stone.com; www.beechbros.co.uk; www.originalstyle.com; www.stbridgetnurseryseries.co.uk; www.amtico.com; www.opiesuk.co.uk; www.graceandgloryhome.co.uk;  
 www.sofarooms.co.uk; www.chunkymonkeyfurniture.co.uk; www.wallsandfloors.co.uk; www.desenio.co.uk; www.birlea.com; www.ikea.com.

Paper sourced from sustainable forests and printed using vegetable based inks. © Copyright Gazco Ltd 2022 E & O E



find your retailer

You can find your nearest retailer by visiting:  
[www.gazco.com/retailers](http://www.gazco.com/retailers)



Your Gazco stockist:

GZELECTRIC0322

